

Tangeri

Acoustic lamp

 **NOVERB**
DESIGN

www.noverb-design.com

General

Dimension: 43 x 28 cm

Weight: 4 kg*

Input voltage: 120-230v

Input frequency: 50/60 Hz

Wattage: max. 60 watt

Cable: 2 mt white fabric cable**

Materials: Acoustic Foam UL94-HF1, birch plywood phenolic with transparent finish***

Fixing system: White round metal ceiling canopy, diameter 12 cm (conical plastic cable clamp)

Light point: E27 white metal lamp holder

Certifications:  listed |  PATENTED product

* Verify load capacity of the ceiling prior to installation.

** Different colors and lengths on request.

*** Different finishes on request.

Acoustics

The graph refers to the absorption of a single lamp in an environment of 2 square meters.

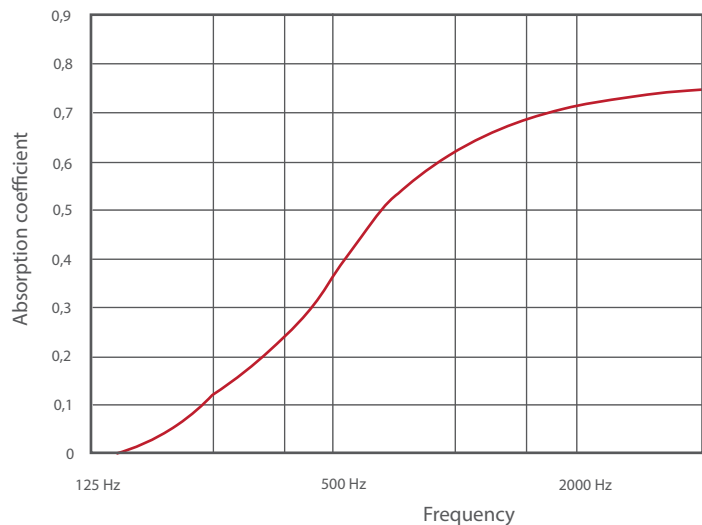

Sound absorbing material

Material: PU Polyether T25 AUX, painted with low Cov content water paint.

Amount: 0,3 mq

Number of slats: 12, tickness 4 cm

Slats hooking: Velcro grip

Density: ISO 845 25 Kg/m³

Flame test according to standard: UL94-HF1

Temperature Range: -20°C / +110°C

Configuration

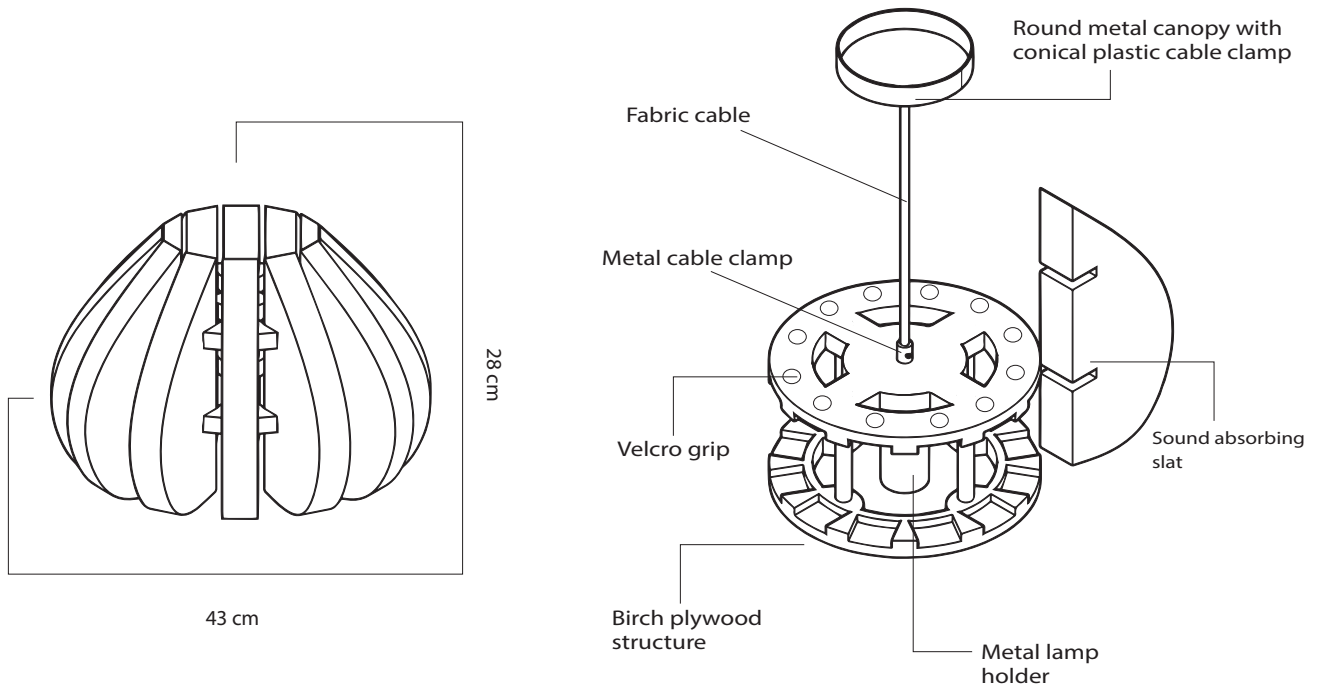

Photometric data

Led bulb reference: 12.5 W, 3000K, 180°,
1500 lumen

Direct light angle: 90°

Diffused light angle: 180° as well as reference
led bulb (through the slats).

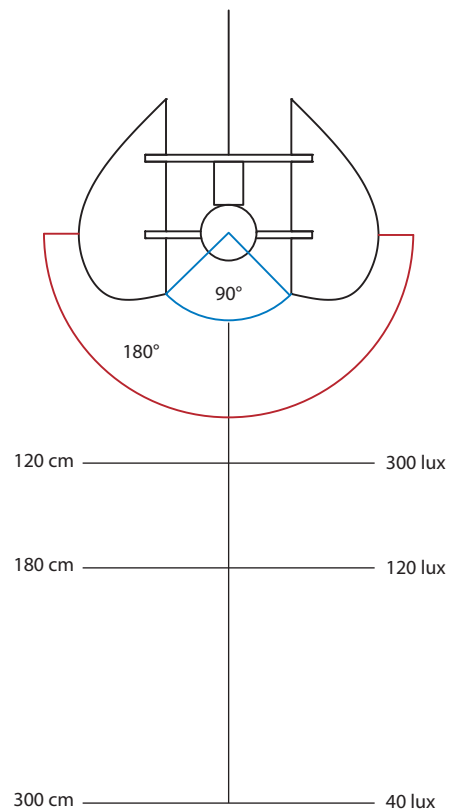

Assembly instructions

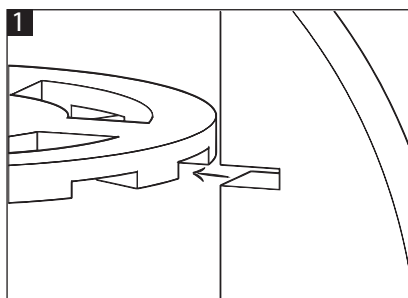

1
Bring the slat closer to the structure making the joints coincide.

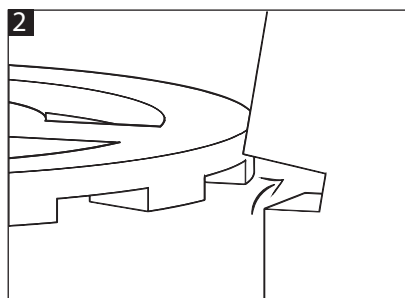

2
Slightly raise the tips of the slat to facilitate insertion.

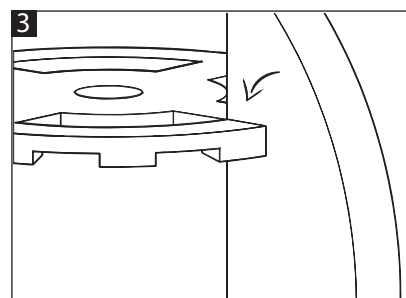

3
Release the tips of the slat and make it stick to the velcro.

Foam colors

Dark green



Light green



Green water



Blue



Red brick

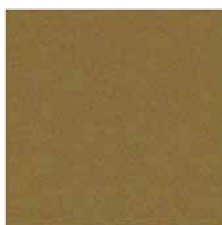

Ocher



Bordeaux



Anthracite



Grey

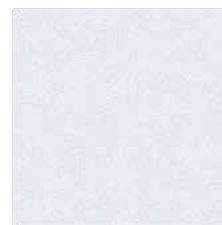

Off white

*Different colors on request.